



LIGITEK

LIGITEK ELECTRONICS CO.,LTD.  
Property of Ligitek Only

---

## SUPER BRIGHT CYLINDRICAL TYPE LED LAMPS

LSR4630

# DATA SHEET

DOC. NO : QW0905-LSR4630

REV. : B

DATE : 03 - Mar. - 2006



### Package Dimensions

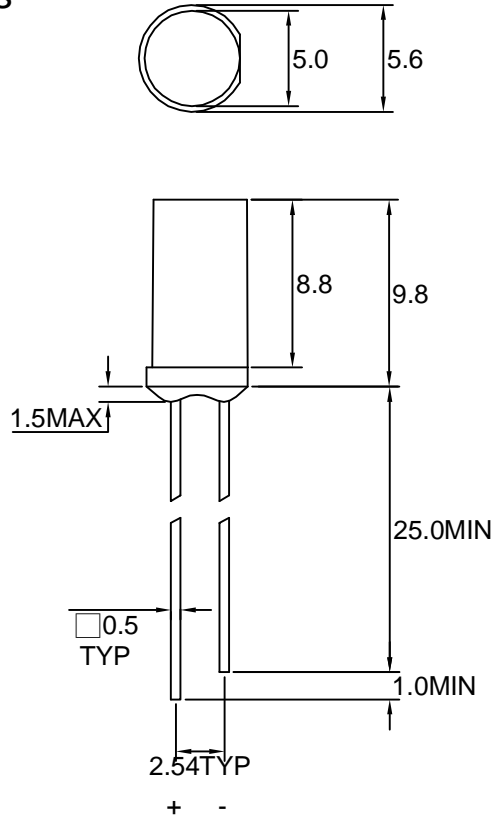

Note : 1.All dimension are in millimeter tolerance is  $\pm 0.25\text{mm}$  unless otherwise noted.  
2.Specifications are subject to change without notice.

### Directivity Radiation

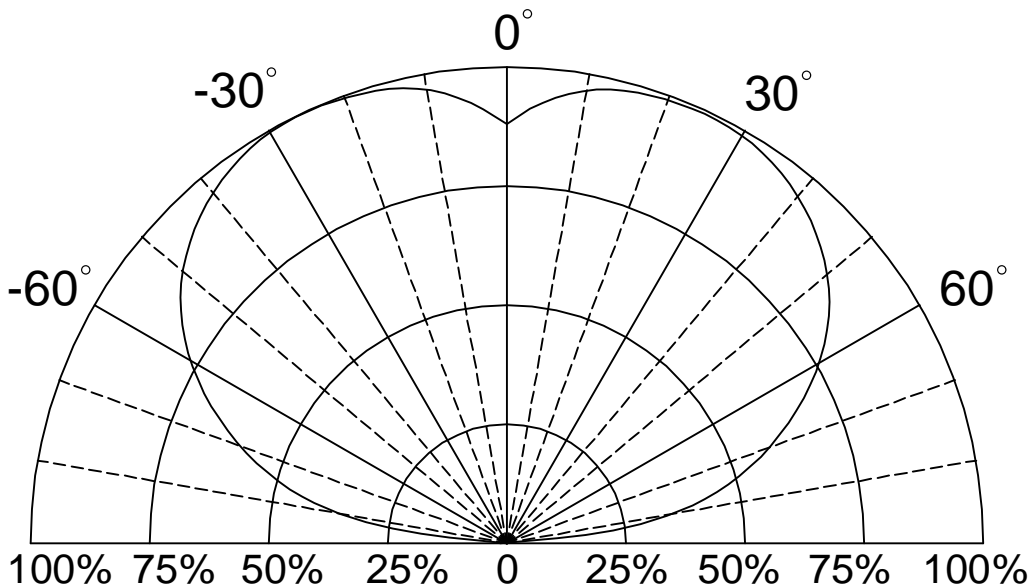

**Absolute Maximum Ratings at Ta=25 °C**

| Parameter                               | Symbol | Ratings                                    | UNIT |
|---|--------|--|------|
|   |        | SR   |      |
| Forward Current                         | IF     | 30   | mA   |
| Peak Forward Current<br>Duty 1/10@10KHz | IFP    | 100  | mA   |
| Power Dissipation                       | PD     | 100  | mW   |
| Reverse Current @5V                     | Ir     | 10   | μA   |
| Operating Temperature                   | Topr   | -40 ~ +85                                  | °C   |
| Storage Temperature                     | Tstg   | -40 ~ +100                                 | °C   |
| Soldering Temperature                   | Tsol   | Max 260°C for 5 sec Max<br>(2mm from body) |      |

**Typical Electrical & Optical Characteristics (Ta=25 °C)**

| PART NO | MATERIAL | COLOR   |              | Peak wave length<br>λ Pnm | Spectral halfwidth<br>Δ λ nm | Forward voltage<br>@20mA(V) |      | Luminous intensity<br>@20mA(mcd) |      | Viewing angle<br>2θ 1/2<br>(deg) |
|---------|----------|---------|--------------|---------------------------|------------------------------|-----------------------------|------|----------------------------------|------|----------------------------------|
|         |          | Emitted | Lens         |                           |                              | Min.                        | Max. | Min.                             | Typ. |                                  |
| LSR4630 | GaAIAs   | Red     | Red Diffused | 660                       | 20                           | 1.5                         | 2.4  | 12                               | 21   | 144                              |

Note : 1. The forward voltage data did not including ±0.1V testing tolerance.  
2. The luminous intensity data did not including ±15% testing tolerance.



### Typical Electro-Optical Characteristics Curve

SR CHIP

Fig.1 Forward current vs. Forward Voltage

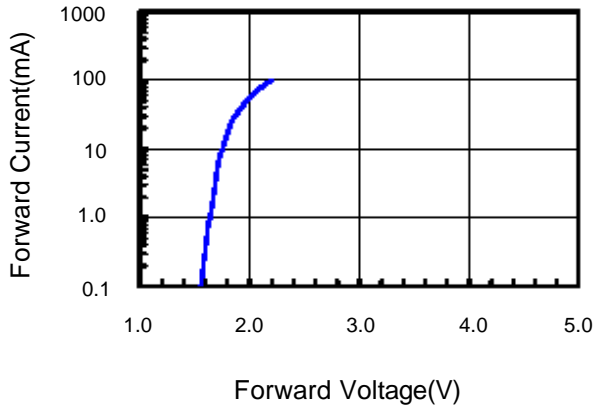

Fig.2 Relative Intensity vs. Forward Current

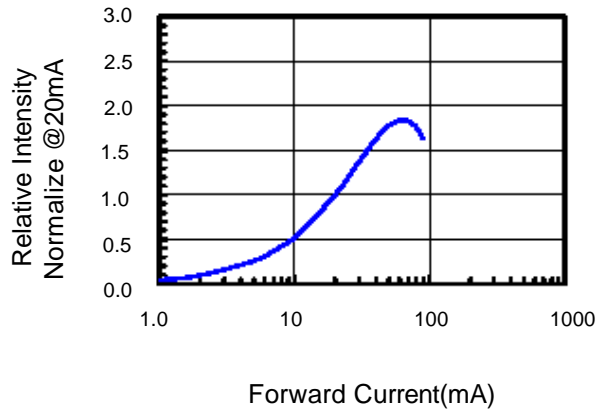

Fig.3 Forward Voltage vs. Temperature

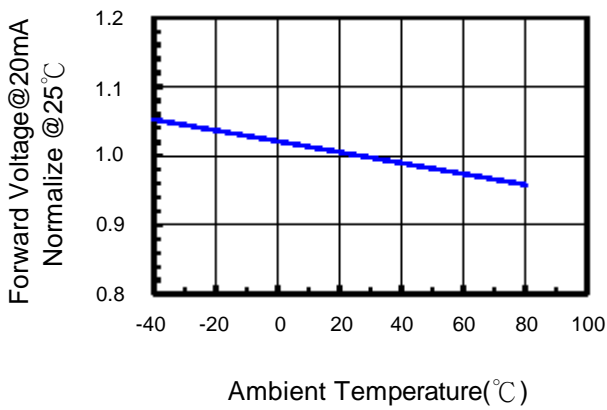

Fig.4 Relative Intensity vs. Temperature

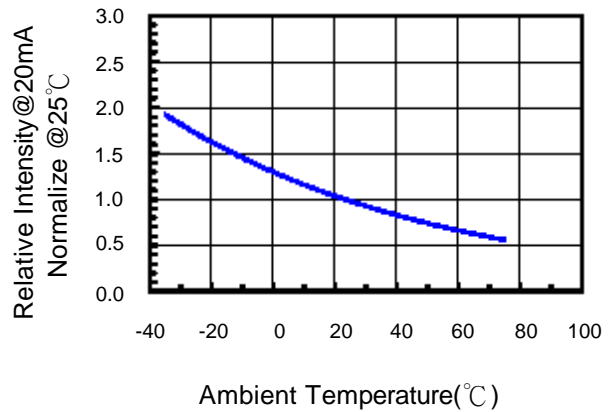
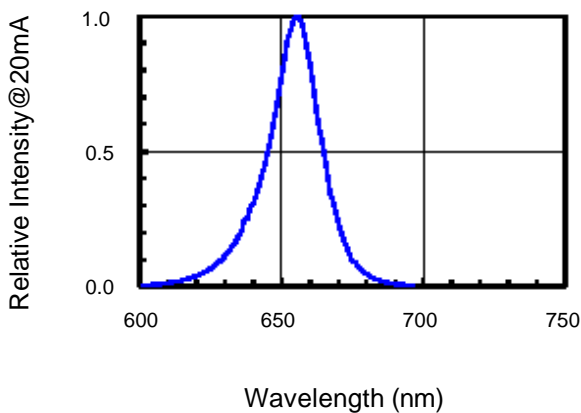

Fig.5 Relative Intensity vs. Wavelength





Reliability Test:

| Test Item                           | Test Condition   | Description   | Reference Standard   |
|-------------------------------------|--|---|--|
| Operating Life Test                 | 1.Under Room Temperature<br>2.If=20mA<br>3.t=1000 hrs (-24hrs, +72hrs) | This test is conducted for the purpose of detemining the resistance of a part in electrical and themal stressed.  | MIL-STD-750: 1026<br>MIL-STD-883: 1005<br>JIS C 7021: B-1                      |
| High Temperature Storage Test       | 1.Ta=105 °C ±5°C<br>2.t=1000 hrs (-24hrs, +72hrs)                      | The purpose of this is the resistance of the device which is laid under condition of high temperature for hours.  | MIL-STD-883:1008<br>JIS C 7021: B-10   |
| Low Temperature Storage Test        | 1.Ta=-40 °C ±5°C<br>2.t=1000 hrs (-24hrs, +72hrs)                      | The purpose of this is the resistance of the device which is laid under condition of low temperature for hours.   | JIS C 7021: B-12   |
| High Temperature High Humidity Test | 1.Ta=65 °C ±5°C<br>2.RH=90 %~95%<br>3.t=240hrs ±2hrs                   | The purpose of this test is the resistance of the device under tropical for hours.  | MIL-STD-202:103B<br>JIS C 7021: B-11   |
| Thermal Shock Test                  | 1.Ta=105 °C ±5°C & -40 °C ±5°C (10min) (10min)<br>2.total 10 cycles    | The purpose of this is the resistance of the device to sudden extreme changes in high and low temperature.  | MIL-STD-202: 107D<br>MIL-STD-750: 1051<br>MIL-STD-883: 1011                    |
| Solder Resistance Test              | 1.T.Sol=260 °C ±5°C<br>2.Dwell time= 10 ±1sec.                         | This test intended to determine the thermal characteristic resistance of the device to sudden exposures at extreme changes in temperature when soldering the lead wire. | MIL-STD-202: 210A<br>MIL-STD-750: 2031<br>JIS C 7021: A-1                      |
| Solderability Test                  | 1.T.Sol=230 °C ±5°C<br>2.Dwell time=5 ±1sec                            | This test intended to see soldering well performed or not.  | MIL-STD-202: 208D<br>MIL-STD-750: 2026<br>MIL-STD-883: 2003<br>JIS C 7021: A-2 |